



UV60-11

FUEL ANTI-SIPHON

ULTRA Value

Technical specifications

Product details	
Filler neck type	60mm various
Device Type	Internal
Locking method	Snap-off screws
Device material	Nickel-plated steel
Weight	0.18 kg
Flow speed	120 L/min

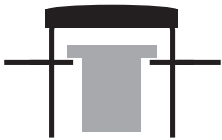

Internal device

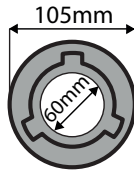

1) Metal Triple bayonet

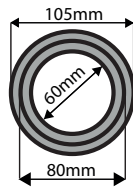

2) Plastic Internal thread



Product dimensions (mm)

Use these dimensions to confirm the product will fit your vehicle

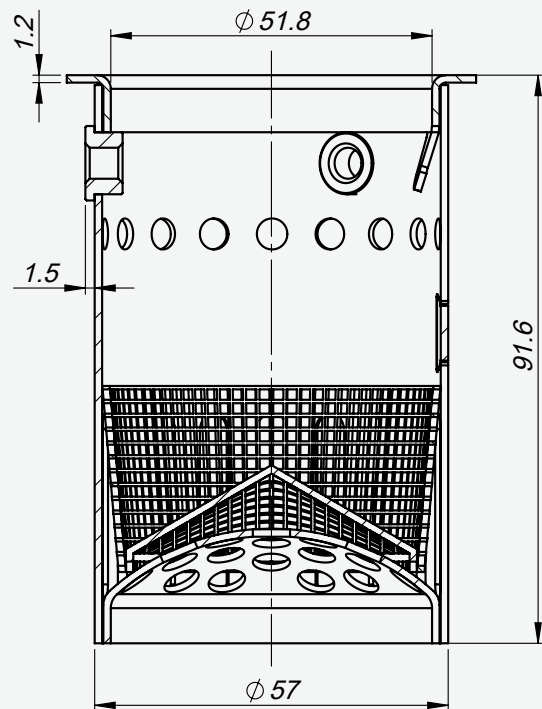
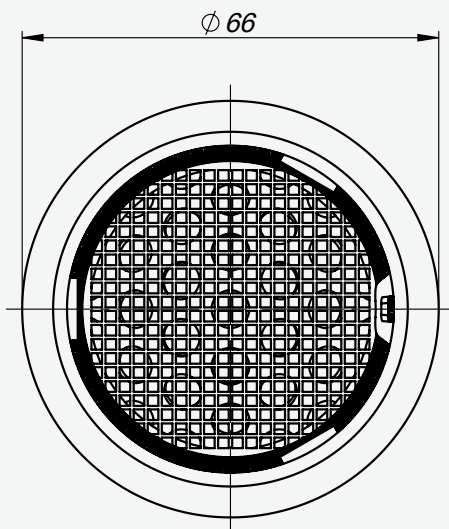

UV60-11 Vehicle Application List

Truck vehicles fitted

	Manufacturer	Models
	DAF	LF, CF65
	Renault	Midlum, D range
	Volvo	FE, FL - (2006 - current)
	Hino	500 & 700 Series

Other vehicles & machinery

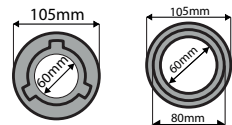
	Manufacturer	Models
	Other	<i>There are more vehicles with the same filler neck, please contact us for more details.</i>