



**UP60-7**

**FUEL ANTI-SIPHON**

**ULTRA Plus**

**Technical specifications**

Product details	
Filler neck type	60mm Internal thread
Device Type	External
Locking method	Grub screws and Security collar
Device material	Aluminium alloy
Weight	0.54 kg
Flow speed	120 L/min

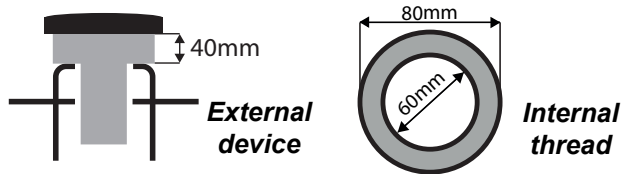

**Product dimensions (mm)**

Use these dimensions to confirm the product will fit your vehicle

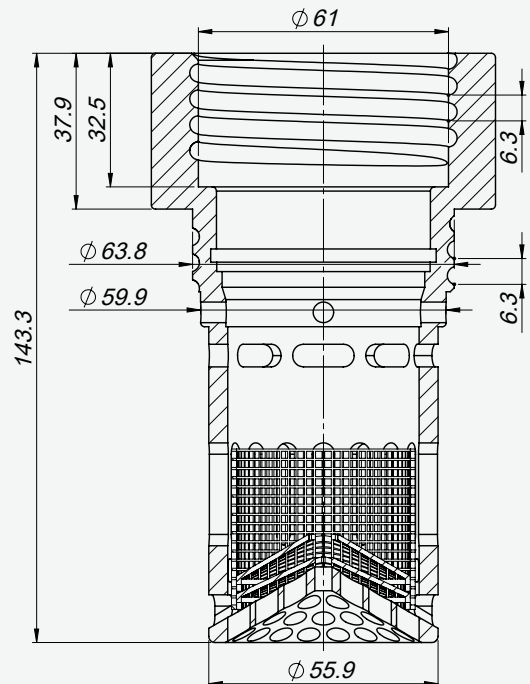
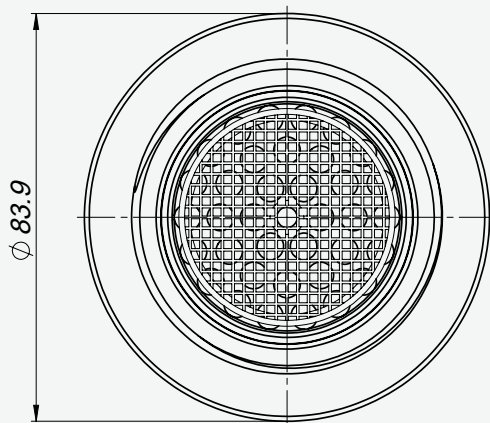

**Optional Accessories**



**Anti-spill valve - ASV0002**  
Prevents fuel spillage



**Drift tool - ACC0025**  
Facilitates security collar installation



**Refitting Kit - ACC0107**  
Allows reinstallation  
not actual kit

# UP60-7 Vehicle Application List

## Truck vehicles fitted

	Manufacturer	Models
	IVECO	<i>EuroCargo (plastic tank 2003-2013)</i>
	Mercedes-Benz	<i>Plastic tank (screw type) - South America</i>
	Scania	<i>Metal tanks: post 1996 (screw type)</i>
	Schmitz Cargobull	<i>Refrigerated trailers</i>
	Volvo	<i>Plastic tank (screw type) - South America</i>
	Volkswagen	<i>Constellation - South America</i>

## Bus vehicles fitted

	Manufacturer	Models
	Marco Polo	<i>All models - Plastic tank (screw type)</i>

## Construction vehicles fitted

	Manufacturer	Models
	Bomag	<i>Some models - Plastic tank (screw type)</i>
	Case New Holland	<i>Most models - Plastic tank (screw type)</i>
	Deatz Fahr	
	JCB	
	John Deere	
	Manitou	<i>MLT loaders - Plastic tank (screw type)</i>
	Massey Ferguson	<i>Most models - Plastic tank (screw type)</i>
	McCormick	
	New Holland	
	SAME	

## Other vehicles & machinery

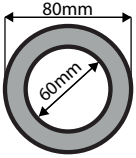
	Manufacturer	Models
	Atlas Copco	<i>Generators - some models</i>
	Other	<i>There are more vehicles with the same filler neck, please contact us for more details.</i>